



USPA 6800 U

OWNER'S MANUAL





PRODUCT INFORMATION

Important Safeguards.....4
Safety Information.....6
Cautions Before Installation.....8
Main Unit & Parts.....12

PRODUCT INSTALLATION

Installation.....14
Operation.....18

PRODUCT SETTINGS

Cleaning.....26
Maintenance.....28
Troubleshooting.....30
Specifications.....32

WARRANTY

Warranty.....34



READ ALL OPERATING INSTRUCTIONS BEFORE INSTALLATION

NOTES

1. This product should be installed according to this manual.
2. Read this manual carefully and install it properly.
3. Keep this instruction manual in an easily accessible place.
4. Do not attempt to service this appliance yourself. Doing so will void the warranty.

DANGER - To reduce the risk of electric shock.

1. Do not place or store this appliance in a location where it can fall or be pulled into a tub or sink.
2. Do not place in, or drop into water or other liquids.
3. Do not touch a product that has fallen into the water. Unplug immediately.

WARNING - To reduce the risk of burns, electric shock, fire, or injury.

1. Close supervision is necessary when this appliance is used by or is near infants, elders, or handicapped persons. Children should not be permitted to use or touch this appliance without adult supervision. Be sure to adjust the toilet seat's temperature for elders, with disability persons, or people with sensitive skin.
2. Use this appliance only for its intended purpose as described in this manual. Only use attachments recommended by the manufacturer.
3. Do not operate this appliance if the cord is damaged or if the product is dropped into water.
4. Install the unit properly by following the installation procedure.
5. Only authorized persons can install or repair the unit. Do not attempt to service this appliance by yourself. Doing so could void the warranty.
6. Keep the cord away from heated surfaces.
7. Never drop or insert any objects into any opening or hose.
8. Do not use outdoors. Do not use aerosol or oxygen spray products on the unit.
9. Always follow the grounding instructions in this manual before plugging in the unit.

SAVE THESE INSTRUCTIONS



DANGER - FOLLOW THESE BASIC INSTRUCTIONS TO ENSURE THE SAFE USE OF YOUR APPLIANCE.

- **Do not use a faulty or loose electric outlet or cord.**
Doing so may result in a short circuit, electric shock, or fire.
- **Do not obstruct the warm air dryer outlet.**
If the outlet is obstructed by any objects, it may result in fire. If the outlet is obstructed with hands, it may result in injury.
- **Do not throw anything flammable into the toilet.**
Doing so may result in fire.
- **Do not splash water on this product.**
Doing so may result in fire or electric shock.
- **This product must be grounded.**
Not doing so may result in a short circuit, electric shock, or malfunction.
- **Do not use too many appliances on one power strip.**
Doing so may result in fire or damage. Be sure to use a dry and clean outlet. Do not use a faulty or loose outlet.
- **Plug and unplug properly.**
Do not plug or unplug with wet hands. It may result in injury or a short circuit. Do not grab the cord when unplugging. Pull out the plug properly.
- **Do not use it when the seat and lid are disassembled.**
Doing so may result in electric shock due to high voltage inside.
- **Unplug when beeping or emitting a strange odor.**
Unplug right away. Contact your dealer where you bought this appliance.
- **Do not disassemble, repair, or modify this appliance.**
Doing so may result in fire or electric shock.
- **Use tap potable water only (Groundwater).**
Not doing so may cause irritation or injury.

WARNING - FOLLOW THESE BASIC INSTRUCTIONS TO ENSURE THE SAFE USE OF YOUR APPLIANCE.

- **Do not step on or place heavy objects on this appliance.**
Doing so may damage the unit.
Doing so may result in a malfunction of the appliance.
- **Do not force the lid to close.**
Doing so may cause malfunction.
- **Be aware of urine splash on a nozzle or a dry air outlet.**
Doing so may result in an unpleasant odor or failure of the appliance.
- **Do not sit or lean against the lid or control panel.**
Doing so may cause malfunction or breakage.
- **Unplug if you do not plan to use it for a long period of time.**
- **Unplug while there is thunder or lightning.**
- **Do not pull out the water hose forcefully.**
Doing so may cause water leakage.
- **Use this appliance on a toilet only.**
Not doing so may result in fire, injury, or electric shock.
- **Do not put a vase, water cup, or small materials on this appliance.**
- **Be aware of low-grade burns.**
Sitting on the heated seat for a long time may result in a low-grade burn. Use care when being used by the following: Children, senior citizens, patients, or others who can not control the temperature level. Sleeping pill users or people who are on medication that causes drowsiness. Those who are intoxicated or very tired may fall asleep while sitting on the unit.
- **Unplug when cleaning.**
Not doing so may result in fire or electric shock.
- **Use the low temperature for children and disabled.**
High temperature may result in burns due to not recognizing the temperature.

WARNING: Risk of electric shock, fire, or personal injury. This product must be grounded and connected only to a dedicated, nominal 120 VAC, 60 Hz circuit protected by a minimum 15 A Ground-Fault Circuit-Interrupter (GFCI)



NOTE THE FOLLOWING IMPORTANT POINTS

1. Do not install in a location where water might be splashed on this appliance or in a location exposed to excessive moisture where condensation might form on the product's surface.
2. To avoid damage to electronic components due to high levels of humidity, provide adequate ventilation by opening a window and/or door when bathing.
3. The water supply should have a water pressure of 0.07 MPa to 0.74 MPa.
4. Connect the product to a pipe carrying potable water. Do not connect to an industrial water line or other water supplies that are not potable.
5. Cool the unit in the room before installation.
6. The thermal protector in the water tank may malfunction when transporting or storing warm water.
7. The rated power voltage in AC 120V, 60Hz
8. Do not plug the unit in until installation is complete. It may result in malfunction.

WIRING REQUIREMENTS

1. After installation, all other servicing should be performed by authorized service representatives.
2. **Grounding Instructions** - This product should be grounded. In the event of an electrical short circuit, grounding reduces the risk of electric shock by providing an escape wire for the electric current. This product is equipped with a cord having a grounding wire with a grounding plug. They must be plugged into an outlet that is properly installed and grounded.

DANGER - Improper use of the grounding plug can result in a risk of electric shock.

If it is necessary to repair or replace the cord or plug, do not connect the grounding wire to a flat blade terminal. The grounding wire can be identified by its insulated outer surface. It will either be colored green or will not contain yellow stripes.

Check with a qualified electrician or serviceman if you do not understand the grounding instructions or if you do not know whether the product is properly grounded.



CAUTIONS BEFORE INSTALLATION (CONT.)

- This product is for use on a nominal 120V circuit. It has a grounding plug that is similar to the plug illustrated in sketch A. A temporary adapter, which looks like the adapter illustrated in sketches B and C may be used to connect this plug to a 2-pole receptacle as shown in sketch B if a properly grounded outlet is not available. The temporary adapter should be used only until the properly grounded outlet (sketch A) can be installed by a qualified electrician. The green-colored rigid ear, lug, and the like extending from the adapter must be connected to a permanent ground such as a properly grounded outlet box cover. Whenever the adapter is used, it must be held in place by the screw.

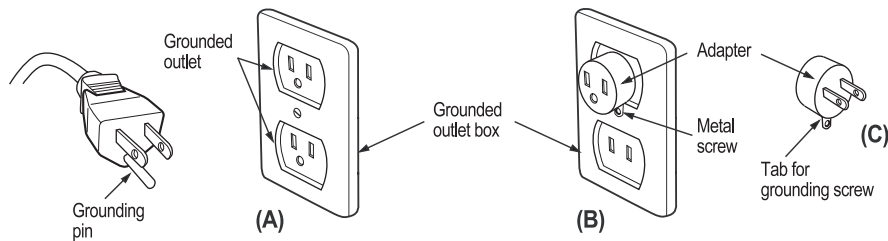

- If it is necessary to use an extension cord, use only a three-wire extension cord that has a three-blade grounding plug, and a three-slot receptacle that will accept the plug on the product. Do not use a damaged extension cord.
- Remote Control Power: AAA (1.5V) , 3EA

CAUTION - RISK OF EXPLOSION TO BATTERY IF REPLACED BY AN INCORRECT TYPE. DISPOSE OF USED BATTERIES ACCORDING TO THE INSTRUCTIONS.

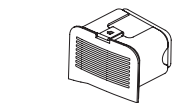
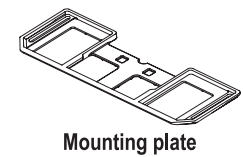
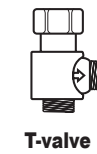
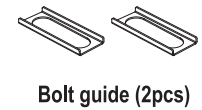
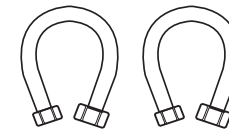
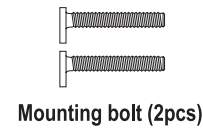
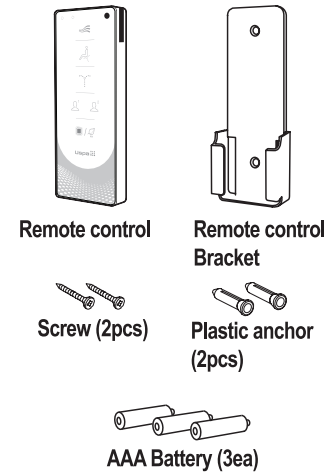
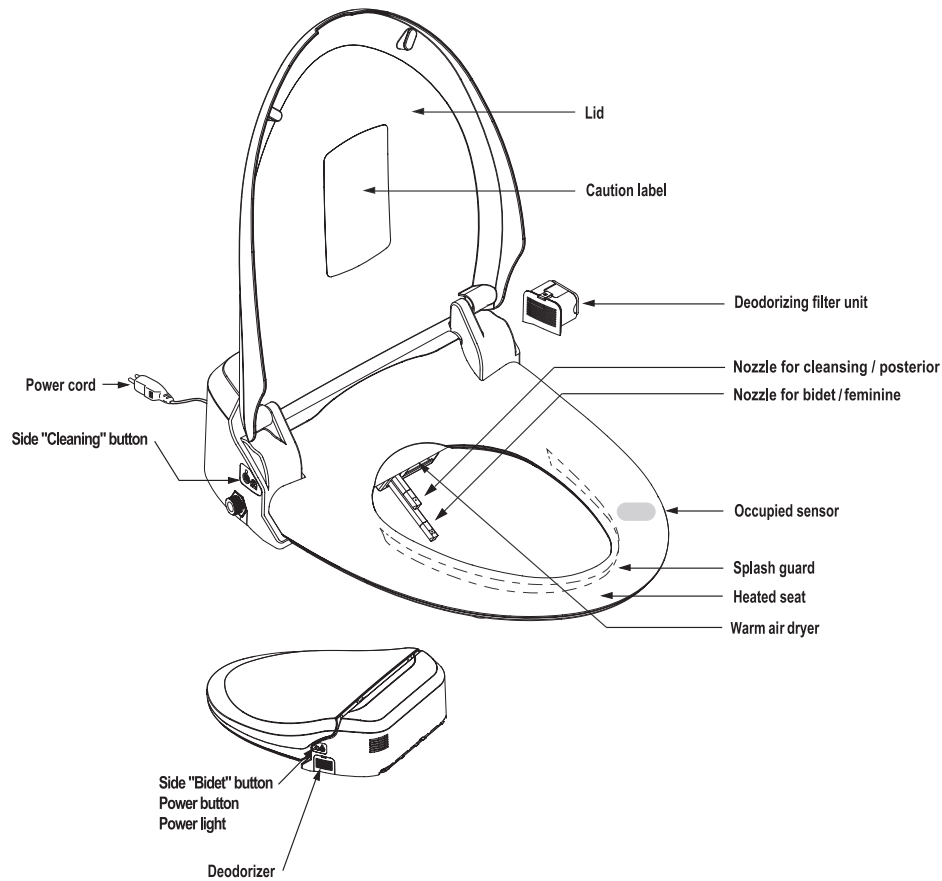



CAUTION - Do not plug in until installation is finished. Not doing so may damage the appliance.

If electric work is needed, please contact a qualified electrician or serviceman only.

Remove the Existing Toilet Lid and Seat

1. Remove the nuts, washers, and cone packings from the toilet seat and mounting bolts in the back of the toilet.
2. Remove the toilet seat, lid, and mounting bolts.
3. Keep them in case you need them.

Toilet Size (Elongated & Round Front)

The toilet dimensions must be within those shown on the right. Do not install this appliance on a toilet that does not meet these dimensional requirements.

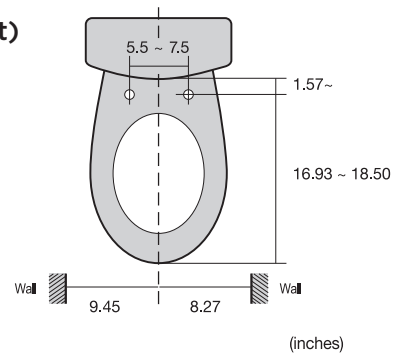

Occupied Sensor

1. This appliance is equipped with an occupied sensor.
2. The unit will not work unless the seat is occupied.

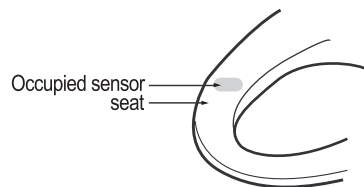

Mounting the Plate

Place the mounting plate over each mounting hole. Insert the mounting bolts through the plate and mounting holes. Slide cone packings and washers onto the bolts and fasten tightly with nuts.

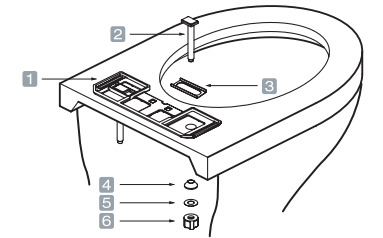

- | | | |
|------------------|-----------------|---------|
| 1 Mounting plate | 2 Mounting bolt | 3 Guide |
| 4 Cone packing | 5 Washer | 6 Nut |



INSTALLATION (CONT.)

Connecting the Water Hose

Connect the other end of the flexible hose from the T-valve to the main appliance.

Using Inline Carbon Filter - The use of an external inline carbon water filter is not required unless the unit is used in an area with extreme hard water. If a carbon filter is used, the filter must be replaced every 6 months. Inline carbon filters can be purchased from any authorized Bio Bidet reseller.

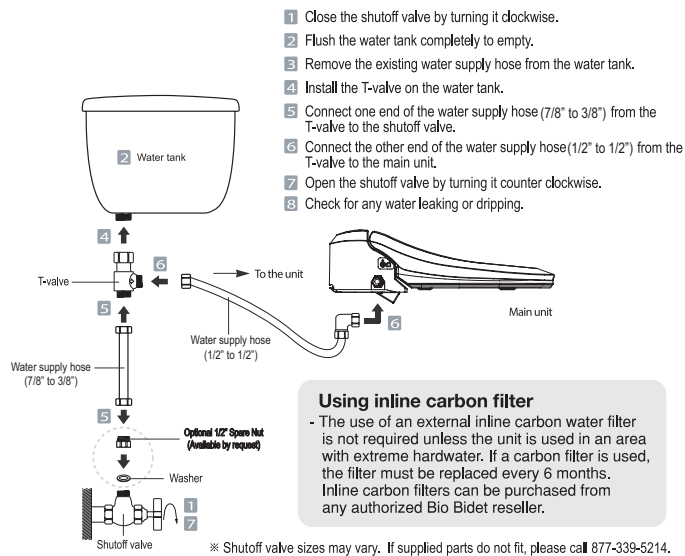

* Shutoff valve may vary. If supplied parts do not fit, please call 877-339-5214

This product is designed and intended for use exclusively with Bio Bidet USPA water filters. The purchase or use of any water filter is not the responsibility of BBC Innovation LLC. As such, any use of non USPA water filters is prohibited and will void the warranty for those Bio Bidet products. Bio Bidet will not be responsible for any resulting damages or claims related to the misuse or distribution of non Bio Bidet USPA filters.

Trial Operation

1. **Preparation**
Plug the power cord into the outlet, and then the water tank will be filled in 2 minutes.
2. **Checking All Functions**
Cover the toilet bowl using the sheet of plastic wrap on the unit to prevent the washing water from being sprayed out of the toilet. Then check for all functions described in this manual.
3. **There are possibilities of water coming out that remains in the unit while heating.**

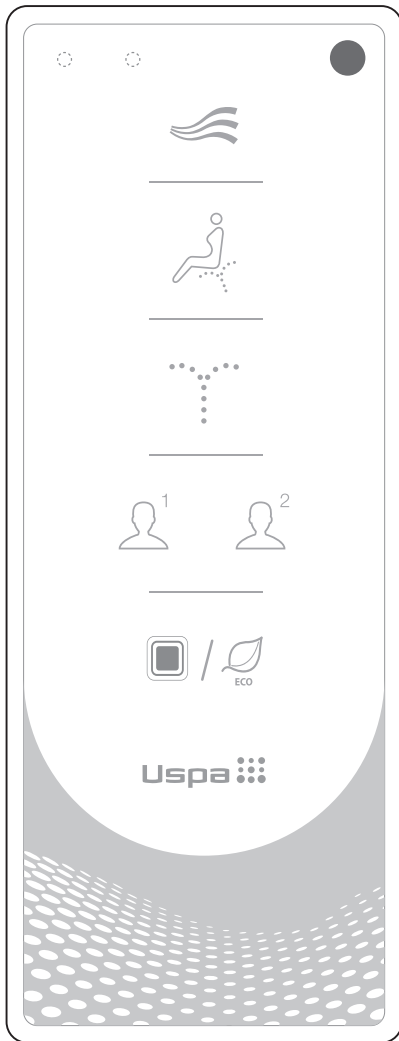

FRONT

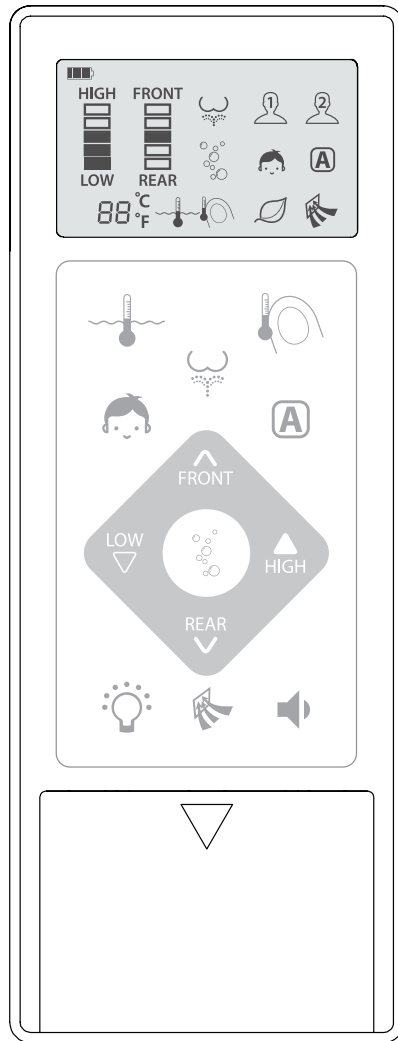

BACK

Dry

- Press “Dry” Warm air will come out for 3 minutes.
- To alter the strength of drying, press the button again.
- Dry temperature can be adjusted by pressing LOW or HIGH on the back of the remote button to 5 levels.

Cleansing

- Press “Cleansing” to clean your posterior. The function will stop in 1 minute automatically.
- Press this button again to activate oscillation. The nozzle moves back and forth automatically to widen the cleansing area. Oscillation wash stops if this button is pressed again.

Bidet

- Press “Bidet” for feminine wash. The function will stop in 1 minute automatically.
- Press this button again to activate oscillation. The nozzle moves back and forth automatically to widen the cleansing area.
- Massage wash stops if this button is pressed again.

Stop



- Press “Stop” to stop the current operation.
- When a user stands up, all operations will stop automatically. (Except for kids function)

Eco

- Press “Eco” for 2 seconds to activate the power-saving mode. Seat and water temperature will set to low but temperature will keep remain at room temp.



Temperature Adjustment (Water/Seat)

- The temperature of seat and water can be adjusted by pressing  or  button located on the back of the remote.
- There are 4 levels (Off-Low-Medium-High)

Battery Alarm

- Change the batteries if the battery icon on LCD is flickering (LED on the front also flickers)

Massage

- Press "Massage" to activate rhythmical wash for massage effect when you are using "Cleansing", "Bidet", "Kids", or "Auto".
- Press the button again to release this function.

Kids

- Press "Kids" to change all functions to be suitable for children. It will automatically operate from cleansing (1 min) to dry (3 min) with adequate water pressure (level 1) and nozzle position (level 5).
- This unit should be used under the supervision of an adult.

Auto

- Press "Auto" during the operation of "Cleansing", Cleansing wash (20 sec) - Oscillating wash (20 sec) - Oscillation massage (20 sec)
- Dry (3 min) will operate.

Nozzle Position

- Nozzle position can be adjusted by pressing FRONT or REAR button to 5 levels.
- Nozzle position will return to the position during next use.

Water Pressure (Cleansing/Bidet)

- Water spray pressure can be adjusted by pressing LOW or HIGH button to 5 levels.
- Water pressure level will return to the position during next use.

Aerated Spray

- This gentle but strong spray cleanses better while using "Cleansing", "Bidet", "Kids", or "Auto".
- The aerated spray is released if this button is pressed again.

LED

- Press the button to activate the light on/off.
- Delicate light will help the user to use the toilet without turning the bathroom lights on during night time.

Deodorization

- When the appliance is in use, the deodorizer will work maximum 20 minutes automatically.
- When a user stands up, the function stops after 1 minute.

Sound

- Press the button to enable the beeping sound.
- To disable, press the button again.



User Setting

- Each button can save 2 settings. (Cleansing, Bidet)
- Press the User 1 button and Cleansing or Bidet consecutively. Then choose nozzle position by pressing the FRONT/REAR button and water pressure level by pressing the LOW/HIGH button. Press User 1 again will save the setting with a beep.
- The same applies to saving the User 2 setting.
- Press User 1 or User 2 while using cleansing or bidet to operate saved settings.

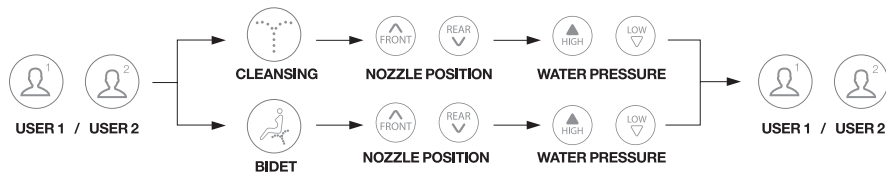

Side Control Buttons

- Use side control buttons on the unit when the remote control is broken or its batteries are dead.
- Press “cleansing” on the right side or “Bidet” on the left side to start.
- Press again to stop. Do not press buttons with sharp-edged items.

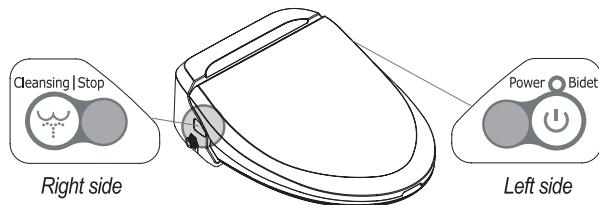

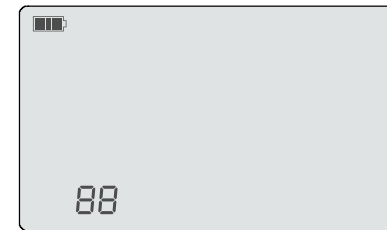

Identification

- This function is useful for public toilets when more than one unit of this product is installed.
- To prevent interference among units, the main unit and remote control should be set with the same ID.
- If there is only one unit in the bathroom, you do not need to set the ID.
- The initial ID of the remote and main unit is “0”.
- There are 16 choices in ID (00-15).



How to Set ID (Remote Control)

- Press the “High”  button for 3 seconds and ID will show up in the display.
- Press the “High”  or “Low”  button until your ID appears in the display. (00-15)
- Press “Stop” to save the ID.



Set the Unit

- Unplug the unit and then plug it back in.
- Push the power bidet button on the side of the unit to turn the unit off.
- Push the button again and this time hold it down (It should turn on when you do this).
- While holding that button down, push the stop button on the remote for 2 seconds.

Note

- If the ID's of the remote control and the main unit are different, the main unit will not work.
- Make sure the remote control and the main unit are set with the same ID.
- ID will remain even when the power is unplugged or the batteries of the remote control are replaced.



CAUTION: Do not forcefully push, pull, or bend the nozzles. It may result in failure. Make sure to use the “Stop” button on the remote control.

NOZZLE CLEANING

Manual Cleaning

1. Make sure the occupied sensor is not activated. (Do not sit on the seat or place hands on the seat sensor)
2. Press Front FRONT button for 2 seconds to extract the bidet nozzle. Press the button again to extract the cleansing nozzle.
3. Use a toothbrush or soft cloth to clean the nozzle.
4. Press the Stop button to retract the nozzle.



Auto Cleaning

1. Press the Rear REAR button for 2 seconds to start auto cleaning. The nozzle will be cleaned for 30 seconds and returned automatically.
2. Press the Stop button while cleaning to retract the nozzle.
3. Do not force to push or pull the nozzles while cleaning.

Strainer Maintenance

- This appliance will not operate properly if the strainer is clogged. Be sure to clean the strainer regularly.

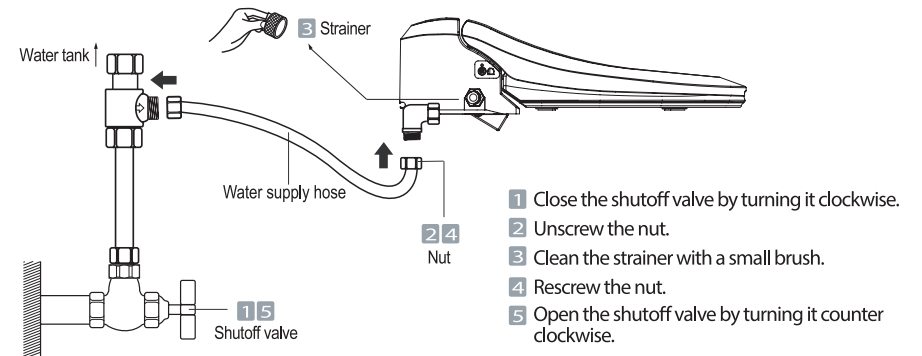

Cleaning The Body

1. Regularly wipe off the body with a dry soft cloth, sponge, or wash with a damp cloth and mild detergent.
2. In order to protect the plastic unit, only use neutral cleansers. (Do not use toilet cleaners, home cleansers, bleach, benzene, paint thinner, cresol (Lysol))





Draining Water - while not using it over extended period of time.

1. Unplug the Power Supply Cord.

- Not doing so may cause electric shock or fire.

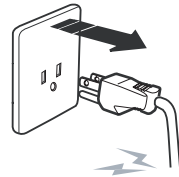

2. Close the Shutoff valve.

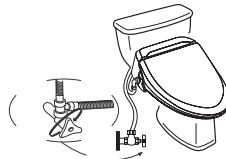

3. Lift the Unit Up and Slide it Forward.



4. Drain Bolts

- Raise the unit and thoroughly drain the water by unscrewing the drain bolt. Beware of losing the drain bolt.
- The following figure is only to check the location of the 'Drain Bolt'. To prevent malfunction, do not place in the vertical position or tilt the product.

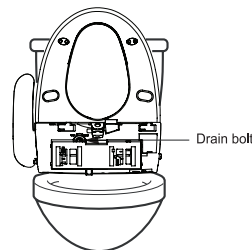

5. Screw the Drain Bolt and Install the Appliance

- Refer to the trial operation method in order to use this appliance again.

Prevent Freezing

1. Make sure the power cord is plugged properly.
2. Set the temperature of water to low or middle. (Freezing can be prevented by thermal efficiency of the water tank.) If there is no heating system in the toilet, wrap pipes with a cloth or other materials.
3. If the unit has not been used for a long time in the winter, unplug and drain the water from the water tank and pipes thoroughly. Refer to the drain water method.



PROBLEM	POSSIBLE CAUSE	POSSIBLE SOLUTION
Unit completely fails to work or power on	<ol style="list-style-type: none"> 1. Power outage 2. The unit is not plugged in. 3. Skin sensor is not activated. 	<ol style="list-style-type: none"> 1. Reset the GFI outlet. 2. Plug the power cord in to a GFI outlet. 3. Test another appliance in the outlet. 4. Activate the skin sensor on the unit.
Nozzle does not extend	<ol style="list-style-type: none"> 1. Remote control is not working. 2. Nozzle is dirty. 3. External bidet filter. 4. Skin sensor is not activated. 5. Seat riser is covering the skin sensor. 	<ol style="list-style-type: none"> 1. Replace the remote control batteries and try to operate the unit with the side control panel. 2. Clean the nozzle. 3. Remove the external bidet filter. 4. Activate the skin sensor on the unit. 5. The seat riser must go underneath the bidet seat.
Low water pressure	<ol style="list-style-type: none"> 1. Clogged nozzle tip. 2. Water pressure is set to low on remote. 	<ol style="list-style-type: none"> 1. Clean the nozzle tip. 2. Raise the water pressure on the remote control.
Seat is not heating	<ol style="list-style-type: none"> 1. Unit is set on Economy mode. 2. Remote control batteries. 	<ol style="list-style-type: none"> 1. Turn off Economy mode. 2. Replace batteries 3. Unplug the unit for 10 sec.
Stops in the middle of use	<ol style="list-style-type: none"> 1. Washing or drying exceeded cycle time. 2. Skin sensor lost contact. 3. Clogged nozzle tip. 	<ol style="list-style-type: none"> 1. Press the wash or dry mode again. 2. Activate the skin sensor with full skin contact through the entire cleansing period. 3. Clean the nozzle tip.

PROBLEM	POSSIBLE CAUSE	POSSIBLE SOLUTION
Water coming out from the nozzle unexpectedly	<ol style="list-style-type: none"> 1. Self-cleaning 	<ol style="list-style-type: none"> 1. The unit will self-clean the nozzle before and after each use automatically.
Water leaking continuously	<ol style="list-style-type: none"> 1. Leaking from hose connection at the unit. 2. Leaking from T-valve. 3. Leaking from behind or under the tank. 	<ol style="list-style-type: none"> 4. Check to make sure that all rubber washers are in place and do not over tighten the connection but it should be secure. 5. Check to make sure that the rubber washer is in place with the flat side pointing up. 6. Check that the train is not opened on the unit if the unit continues to leak, immediately disconnect it from the water supply, drain the tank, and contact the BBC service center.



ITEM		UB-6800U/UB-6800US
Standard power supply		AC 120V 60Hz 660W
Water Supply	Way of connection	Direct connection to tap water
	Water pressure	0.07 MPa - 0.74 MPa
Cleansing	Spray for cleansing	900 (±100) ml/min
	Spray for bidet	900 (±100) ml/min
	Water capacity	800 ml
	Spray temperature	Room temp - 40°C (104°F)
	Heater capacity	600W
	Safety feature	Thermal switch, temperature fuse, floating switch
Dry	Air temperature	Room temp - 60°C (140°F)
	Heater capacity	250W
	Safety feature	Temperature fuse
Heated Seat	Seat temperature	Room temp - 40°C (104°F)
	Heater capacity	55W
	Safety feature	Temperature fuse
Deodorization method		Catalytic filter
Circuit breaker		Within 15mA 0.03 seconds
Length of power cord		1.2m
Dimensions	Elongated	(W) 392mm (15.43 inches) x (L) 520 mm (20.47 inches) x (H) 145 mm (5.71 inches)
	Round Front	(W) 392mm (15.43 inches) x (L) 500 mm (19.68 inches) x (H) 145 mm (5.71 inches)
Weight		4.4Kg (9.7 lbs)

- Recommended water supply pressure is 0.1 - 0.69 MPa.
- The minimum available water supply pressure is 0.07 MPa, however 0.1 MPa pressure, water spray pressure might not be adequate.



USPA Personal Hygiene Appliance Limited Warranty

We warrant our products to be free from manufacturing defects under normal use and service for a period of 3 years prorated base as below from the date of your purchase.

- 100% Coverage of all parts and labor for the entire product for the first year from the original date of purchase.
- 75% Coverage of all parts and labor for the entire product for the second year from the original date of purchase.
- 50% Coverage of all parts and labor for the entire product for the third year from the original date of purchase.

Warranty is valid within the United States and Canada only. Our obligation to you under this warranty is limited to repair or replacement, at our option, of defective products or parts, provided that the products were properly installed and used in accordance with instructions. We reserve the right to make inspections in order to determine the cause of the defect. We will not charge for labor or parts in connection with warranty repairs or replacement. We are not responsible for the cost of removal, return, and/or reinstallation of products.

This limited warranty does not apply to:

- Damage or loss from fire, earthquake, flood, storm, etc,
- Damage or loss resulting from any unreasonable use, abuse negligence, or improper maintenance.
- Damage or loss from improper installation, removal, repair, or modification.
- Damage or loss resulting from sediment or other matters contained in your water system.

This warranty gives you specific legal rights. For warranty or service information, please contact your dealer where you bought this appliance or us. Only the original purchaser may submit a claim under this limited warranty.

This limited warranty is our only warranty covering your product. Repair or replacement as provided under this warranty shall be the exclusive remedy available to you. We shall not be responsible for the loss of the product or for other incidental, or consequential damage or expenses you may incur or for labor or other costs due to installation or removal, or cost of repairs by others, or for any other expense not specifically stated above. Except to the extent prohibited by applicable law, any implied warranties including that of merchantability or fitness for use, are expressly limited to the duration of this warranty.

Warning! We are not responsible or liable for any failure of, or damage to, this plumbing product component caused by in-tank bowl cleaners containing chlorine (calcium hypochlorite).

Note: The use of a high concentration of chlorine related products can seriously damage the fittings. This damage can cause leakage and serious property damage.

For more information, please contact your dealer or us.

BBC INNOVATION LLC

7900 S RT 31 Crystal Lake IL 60014

T: 847-458-2334

F: 847-854-1296

support@biobidet.com

<http://www.biobidet.com>

Thank You



Technical Support/Customer Service
7900 S Route 31 Crystal Lake, IL 60014
T: 847.458.2334
U.S. TOLL FREE: 877.339.5214

support@biobidet.com
www.biobidet.com