



SANCTUARY 5000

S5000E



TABLE OF CONTENTS

Important Safeguards	3 - 4
Product Diagram	5
Parts & Hardware	6
Product Information	7
Toilet Installation.....	8 - 9
Water Connection.....	10
Installing & Replacing Battery Box.....	11
Testing.....	12 - 13
How to Use.....	14 - 17
Maintenance	18 - 19
Remote Installation	20
Functions & Settings	21 - 23
Warnings & Safety.....	24 - 27
Troubleshooting.....	28 - 30
Specifications.....	31
Warranty	32

PLEASE OBSERVE THE FOLLOWING PRECAUTIONS AND INSTRUCTIONS BEFORE INSTALLATION AND USE.

DANGER - To reduce the risk of electrocution:

Do not place or store product where it can fall or be pulled into a tub or sink.

Do not place in or drop into water or other liquid.

Do not reach for a product that has fallen into water. Unplug immediately.

WARNING - To reduce the risk of burns, electrocution, fire, or injury to persons:

- This product must be connected to a GFCI receptacle (wall outlet). Do not connect the power cord if it is damaged or broken. Do not plug the product into a loose electric outlet.

It is recommended to operate this product on a separate circuit. Sharing a circuit could cause the breaker to trip or lights to flicker.

Consult a qualified electrician or service person if you are not sure whether the unit is properly grounded.

- Do not open this product for repair without authorization from the manufacturer. Only qualified service personnel should service this product. Do not use accessories not recommended by the manufacturer.
- Connect this product to a potable cold water supply line.
- Close supervision is necessary when this product is used by children, elderly, or adults with sensitive skin. A low temperature burn may occur when the skin has been in contact with an object at relatively low temperature for an extended period of time.
- If using any chemical toilet bowl cleaner, be sure to wipe up any spills that splash onto the bidet. Do not use benzene or any acid chemical detergent, as they can cause discoloration. Only neutral detergents are permitted.

IMPORTANT SAFEGUARDS (cont.)

- Do not plug in the power cord before connecting the water supply hose.
- Install in an area with adequate ventilation to avoid high levels of humidity which can damage the electronic components.
- Do not touch the power cord with wet hands or reach for a product that has fallen into water. Unplug immediately.
- Unplug the bidet seat when cleaning or detaching from the toilet bowl. Do not plug in until plumbing work has been completed.
- Keep the power cord away from heated surfaces to prevent a fire hazard. Keep any flammable materials away from this product at all times.
- Never block the air openings of the product or place it on a soft surface, such as a bed or couch, where the air openings may be blocked. Keep the air openings free of lint, hair, and the like.
- Never use while sleeping or drowsy.
- Never drop or insert any object into any opening or hose.
- Do not use outdoors or operate where aerosol (spray) products are being used or where oxygen is being administered.

SAVE THESE INSTRUCTIONS

PRODUCT DIAGRAM

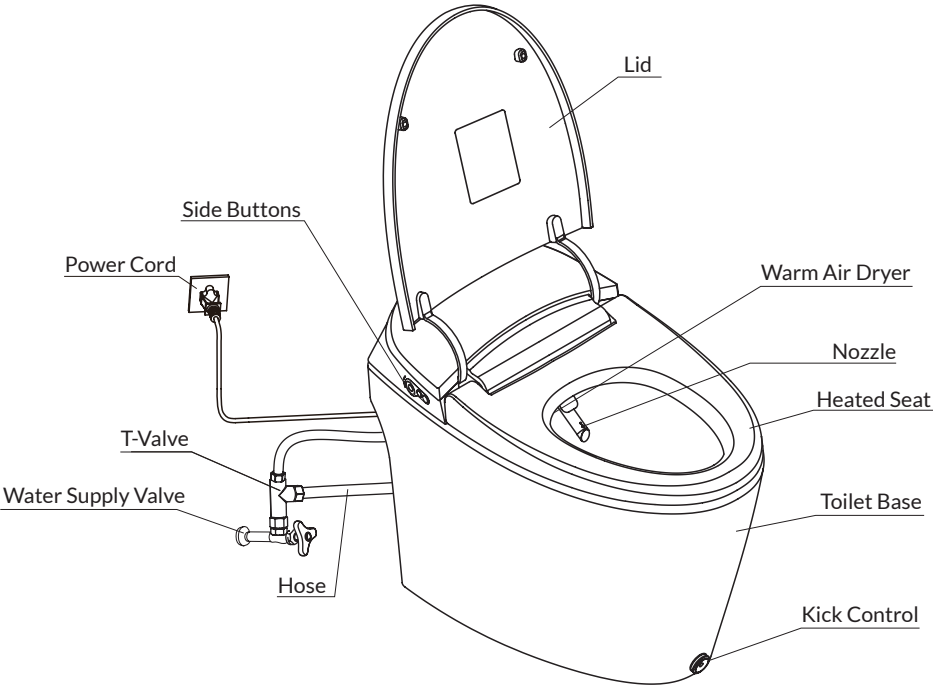

PARTS & HARDWARE

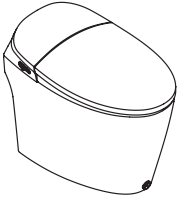

Toilet



T-Valve with
conversion nut



CR2032 Button
Battery (2pc)



Floor Installation
Template



Remote Control
(holder 1pc,
screw 2pc)



Wax Ring (1pc)

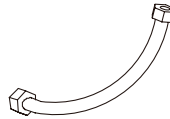

2 Water Supply
Hoses



Floor Flange (1 pc)
Washer (8 pcs)
Hexagon bolt (4 pcs)

REQUIRED TOOLS



Drill (Dia. 0.24in)

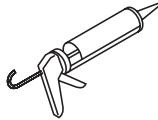

Silicone Gun



Plumbers Tape

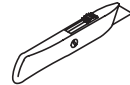

Knife



Marking Pen



0.91-0.98in
(Spanner model varies
for different pipes)

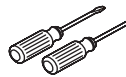

Screwdriver



Measuring Tape

Unit: Inches

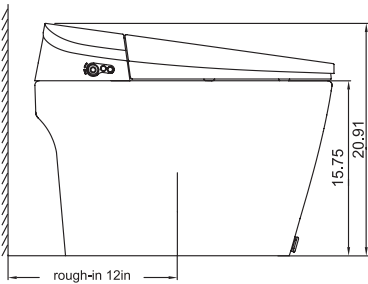

Side View

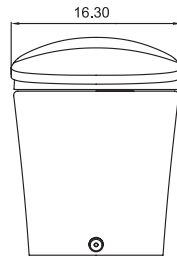

Front View

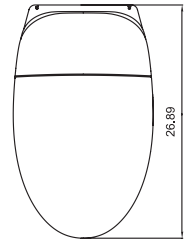

Top View

CHECK WATER SUPPLY

The lowest acceptable water pressure is 0.14 MPa. The highest acceptable water pressure is 0.75MPa. The toilet cannot reach full cleaning functionality if the water pressure cannot reach 0.14MPa.

TOILET INSTALLATION

1. Open box right side up. Remove accessories first, then remove unit from the top as shown in the diagrams.

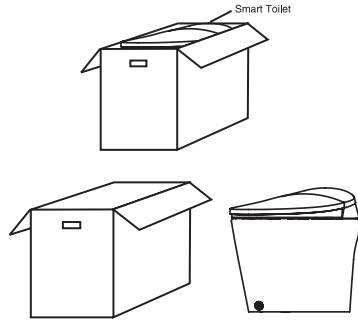

2. Prepare for installation by removing existing toilet and cleaning area near the flange.

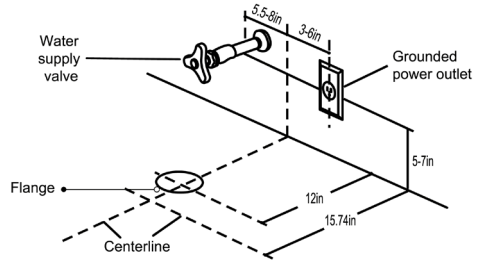

3. Place installation guide over flange and mark perimeter with a temporary marker.

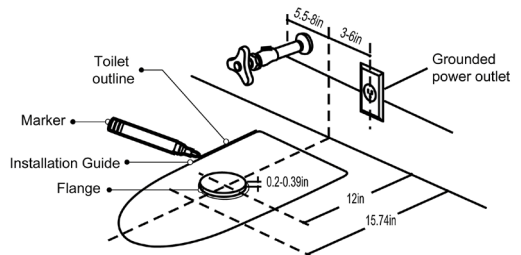

4. Place wax ring and toilet base and position wax ring on the flange. Remove access covers and cap from the water inlet on the back of the toilet. Align toilet over flange and bolts. Carefully lower toilet into flange.

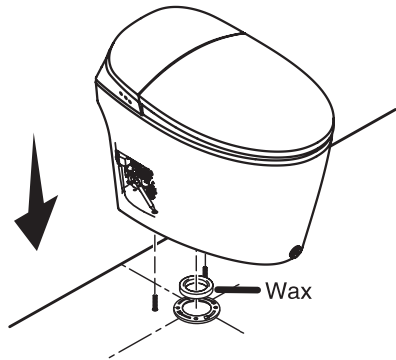

5. Secure toilet base. Press down evenly on the toilet to set the wax ring. Install a washer and nut onto each bolt. Hand tighten the nuts. Use a wrench to tighten the nuts one quarter turn beyond hand tight.

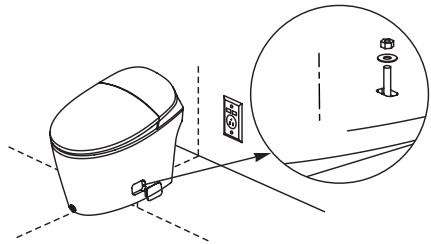

WATER CONNECTION

1. Attach toilet hose to T-valve and Sanctuary 5000.

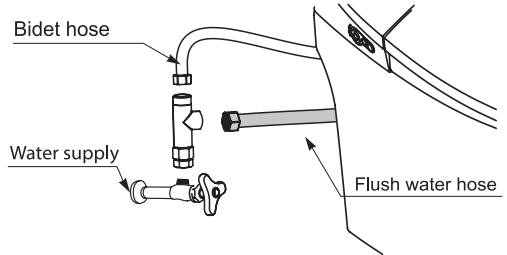

2. Attach bidet hose to the T-valve and Sanctuary 5000.

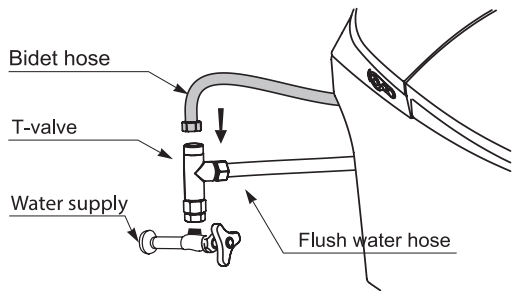

3. Connect T-Valve to water supply valve.

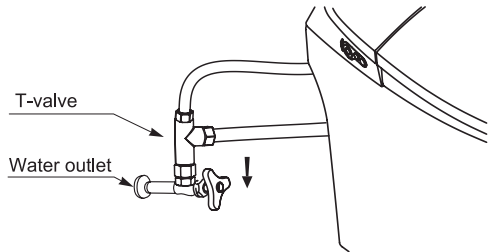

INSTALLING BATTERY BOX

1. Remove extension cable from back of bowl (Cable is attached inside back of toilet. Tug it gently to let it free.)
2. Plug cable into battery box. Then, secure water-proof nuts.
3. Place battery box in its proper position shown on the right. Batteries and cables are divided into positive and negative poles. Do not forcefully connect them. Doing so may damage the product. If you have any questions, please call Bemis Customer Service.

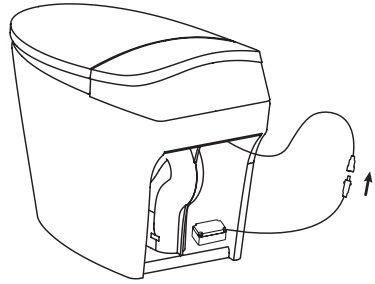

REPLACING BATTERY BOX

1. Loosen battery box screws and remove cover. Remove battery and safely discard.
2. Load new CR-P2 battery and re-secure screws.
3. Place battery box back into place.

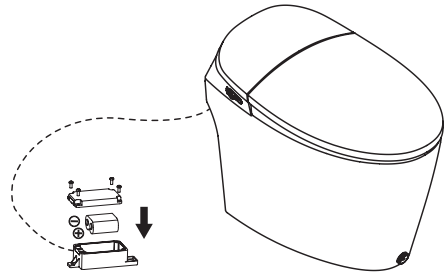

Battery should be kept out of children's reach. Please ensure battery's polarity is correctly matched. If they are incorrect, it may lead to chemical leaks or explosions. The battery box is waterproof, so please make sure all screws are tightly secured to ensure that the box is perfectly sealed.

TESTING

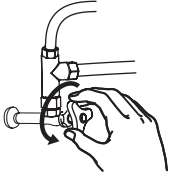

TESTING WATER FLOW

1. Open water supply valve.
2. Check each connection for leaks
3. If leaks occur, turn off water supply valve and reconnect leaking components.

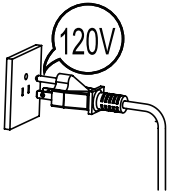

CONNECTING POWER

1. Plug in power cord.
2. Check to see if power light is on.
If not, push reset button.
3. Once the power light is on, toilet will run its initial diagnostics: lights will turn on, cleaning nozzle will extend, motor will begin to run, and water will run through the system. Once the light is off, the self-diagnostic is complete.

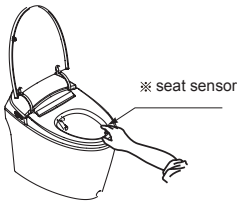



TESTING PRODUCT

1. Are all functions working properly? Please test all functions: Rear Wash, Front Wash (including water pressure and nozzle position adjustment), Heated Dryer, Water and Seat Temperature Adjustment, Nozzle Cleaning, Deodorization, and Remote Control.
2. To check posterior wash, place a hand on the sensor point (shown in the illustration), press Posterior on the Side Control Panel or the wireless remote. Use your hand to block the nozzle spray.

REMOTE PAIRING

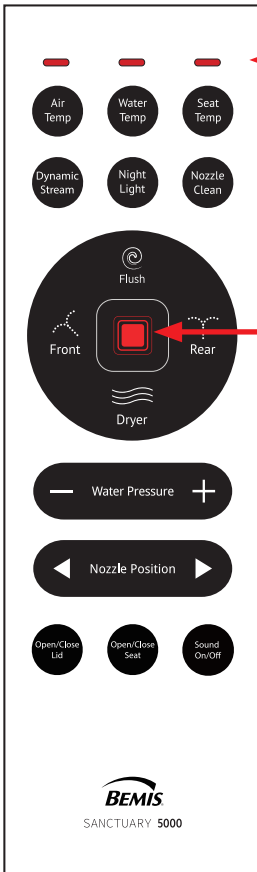
If remote isn't communicating with toilet, remote control will need to be paired with your Sanctuary toilet before use.



1. Unplug product.
2. Press and hold  stop button until red indicator lights flash.
3. Place remote close to the product and plug back in.
4. Red lights will stop flashing and your unit should now be paired.

HOW TO USE

POWER ON/OFF BUTTON

Push the button to power on.
Push and hold the button to power off. Press during a wash to stop all operations.

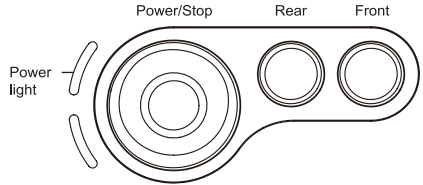

AUTO REAR WASH

Press the auto rear wash button.
When seated, press the auto rear button to start a rear wash for 1 minute, followed by the dryer function for 4 minutes. If you press the button again during a wash, it will skip to the dryer.

NOTE: After 24 hours, product will automatically go into power saving mode and all functions will shut off. To turn back on, simply push the Power button on the Side Control Panel.

AUTO FRONT WASH

When seated, press the auto front button to start a rear wash for 1 minute, followed by the dryer function for 4 minutes. If you press the button again during a wash, it will skip to the dryer.

BLACKOUT FLUSH

When the product is unplugged, press the Power/Stop button. If the toilet is not flushing properly, replace the battery.

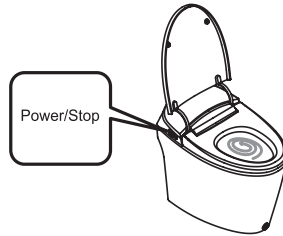

DRYER FLUSH

Press the "Dryer" button. The warm air function is activated and a flush is performed.

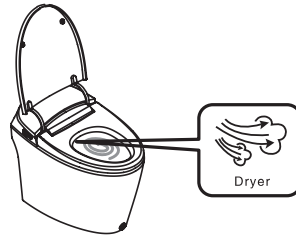

AUTO FLUSH

When the seat sensor no longer detects a user, it will automatically flush. The toilet will only flush once.



KICK FLUSH

Tap the Kick Button with your foot for easy manual flushing. Wash functions cannot be used during a flush.

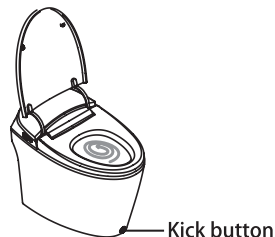

HOW TO USE (cont.)

KICK OPEN/CLOSE LID & SEAT

Tap “Kick Button” with foot to raise toilet seat/lid.

Tap kick button once:
Lid opens.

Tap kick button twice:
Seat raises.

Tap kick button three times:
seat and lid will close; toilet will flush.

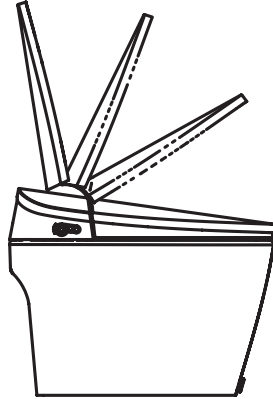

USER-FRIENDLY DESIGN

1. Slow-closing lid/seat. Preserves your toilet's life and allows you to close the lid/seat silently.
2. 8 Layers of Safety. 8 different built-in safety features to protect user and product.
3. Memory mode. After loss of power, temperature, pressure, and nozzle position settings are restored to default settings. Night light will turn on by default.

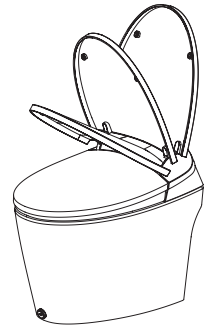

REGULAR MAINTENANCE IS REQUIRED TO ENSURE NORMAL USE.

Note: Cut off power and water supply before maintenance. Direct water wash to the entire product is prohibited.

SURFACE & CERAMICS MAINTENANCE

1. Wipe dust or stains with a soft wet cloth.
2. A wet soft brush, cloth, or sponge may be used to clean ceramic area. Do not use abrasive cleaning solutions, such as alcohol, bleach, paint thinner, cresol, benzene, gasoline, etc.

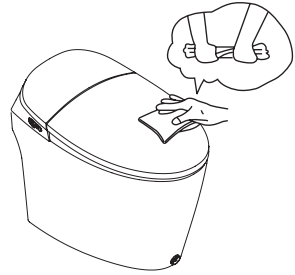

NOZZLE MAINTENANCE

1. Press "Nozzle Clean" button on remote control without occupying seat. Nozzle will extend. Proceed to clean with a soft toothbrush. Do not forcefully hold nozzle.

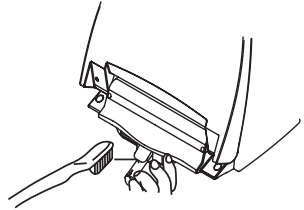

MAINTENANCE (cont.)

WARNING

Do not spray water or detergents on the toilet, remote control or the power cord. Doing so may cause electric shock or fire.



MAINTENANCE DURING WINTER

During winter season, water inside may freeze after long periods of storage and non-usage. Please take measures to prevent.

NOTE

Before connecting product to water supply and electrical outlet, allow it to defrost for 30 minutes in a warm indoor environment.

In cases of extreme cold/freezing/nozzle stuck in place, wrap the water input line with a warm towel. Never pour hot water or use a hot dryer directly on the toilet.

CLEANING THE MESH FILTERS

To clean the mesh filters, the bidet top will need come off.

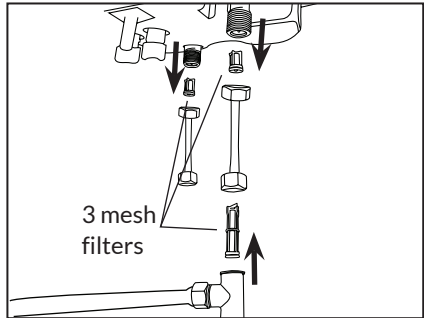
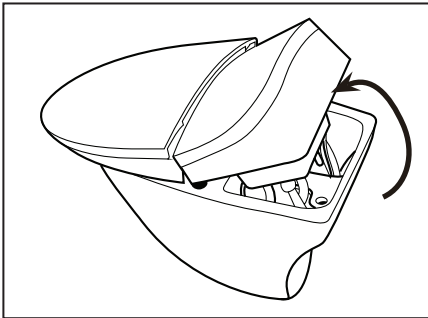
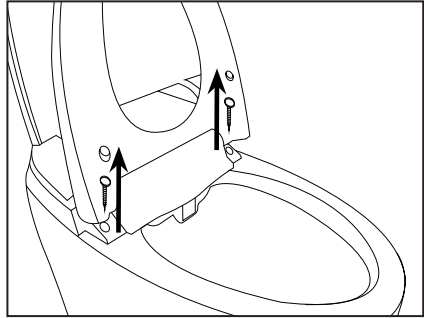
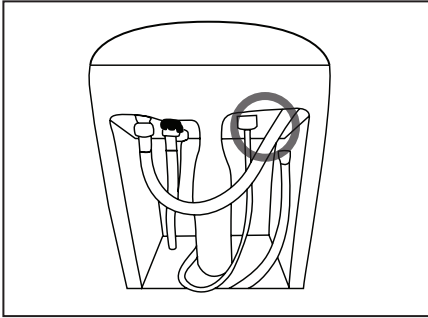

1. Turn off the water supply and unplug the power cord.
2. Unscrew the wing nut behind the bidet.
3. Lift the lid and seat up. Remove the white rubber caps that are covering the two screws underneath.
4. Unscrew the two screws from the base using a Phillips screwdriver.
5. Close the lid and seat and seat. Then pull the top forward.
6. Unscrew the bidet hose connected to the inlet and t-valve. Unscrew the toilet hose. You may need to use an adjustable wrench.
7. Use pliers and carefully pull out the 3 mesh filters.
8. Gently clean the mesh filters using a toothbrush and light cleaning solution.
9. Return the longer filter in the t-valve and shorter filters into the inlets.
10. Turn the water supply back on and plug the power cord in.

REMOTE INSTALLATION

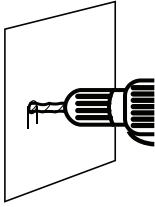

1. Drill two 6 mm holes on wall that line up with remote bracket.

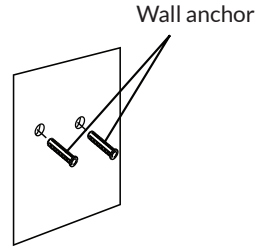

2. Install wall anchors in newly drilled holes.

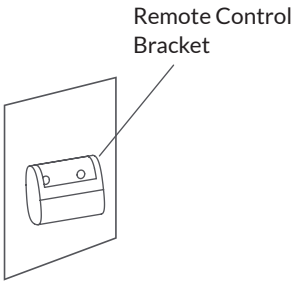

3. Place remote bracket over wall anchors.

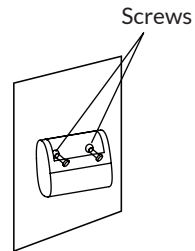

4. Use provided screws to attach remote control bracket to wall.

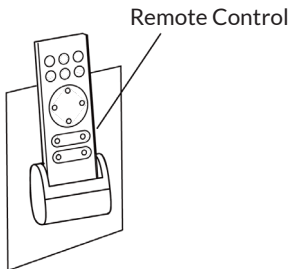

5. Place remote control on bracket.

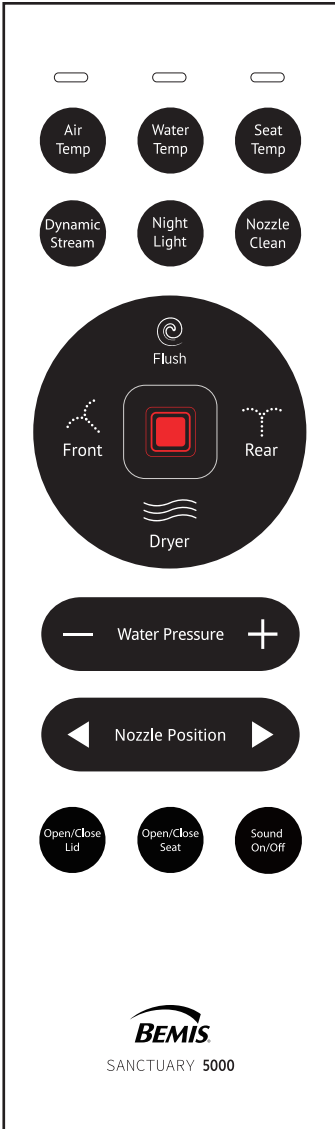

OPEN/CLOSE LID

Press to open or close the lid.

OPEN/CLOSE SEAT

Press to open or close the seat.

SOUND ON/OFF

Press to turn the beeping sound on/off.

FUNCTIONS & SETTINGS (cont.)

FLUSH

Activates flush. The seat must be unoccupied.

FRONT

Press to activate the oscillating front wash.
Press again to turn off oscillation.

REAR

Press to activate the oscillating rear wash.
Press again to turn off oscillation.

STOP

Press to stop any operations.

DRYER

Press to activate the warm air dryer.

AIR TEMP | WATER TEMP. | SEAT TEMP.

Press the corresponding buttons to adjust the temperature settings on each feature.

- Low - Blue
- Medium - Purple
- High - Red

DYNAMIC STREAM

Press during a wash to quickly alternate between hot and cold water.
This feature assists in stimulating bowel movements.

NIGHT LIGHT

Press to turn night light on/off.

NOZZLE CLEAN

Press to extend nozzle for manual cleaning.
This feature can only be activated when seat is not occupied.

WATER PRESSURE

The water pressure starts off low. Press the + or - buttons to adjust water pressure accordingly.

NOZZLE POSITION

Press arrow keys to adjust the position of the nozzle.

POWER/STOP BUTTON

Short press to power on or long press to enter standby mode.
Short press while powered on to stop any operations.

- When power button is red, it is ready to use.

WARNINGS & SAFETY

PLEASE READ THOROUGHLY

First of all, thank you for purchasing our product. To ensure proper and safe use of this product, carefully read this section prior to any usage. Afterwards, store this manual in a safe place for any needed future reference.

The hazards and warnings listed herein are important to our user's safety. Significant consequences may result from failure to heed warnings. The company will not be held liable for any injuries to the user and damages to the product due to improper usage and/or failure to heed safety warnings.

WARNING

- This product needs to be properly grounded. Risk of electric shock. If unsure, contact an electrician.
- Do not touch, insert, or pull out the power plug with a wet hand. Risk of electric shock.
- Do not use a power socket in poor condition or a damaged power plug. Risk of fire and/or electric shock.
- The power socket in use should be within the specified range (AC120V). Risk of fire and/or electric shock.
- Do not pull, damage, bend, twist, stretch, roll, bundle, clamp, or squeeze the power cable. Do not place anything on the power cable. Risk of fire and/or electric shock.
- If the power cord is damaged, to prevent any injuries or accidents, it should be replaced by a professional. Risk of fire and/or electric shock.
- Do not place a lit cigarette along with other burning objects into the unit. Risk of fire.
- Do not use during thunderstorms (pull out the power plug during storms). Failure in doing so may lead to injury or fault in the product.
- When the seat ring or the cover plate is damaged, to avoid any harm, be sure to pull off the power plug, close the water source and contact your local distributor for replacement. Risk of fire or electric shock.
- Regularly pull out the power plug and wipe off any dust on the power plug using a clean dry cloth. Risk of fire.

- Any person with a disability, the elderly, and children, should be using this product with the supervision of another individual. Be advised that sitting on the heated seat for an extended amount of time may result in burns.
- This product is not a toy. Advise children not to play with product. Risk of injury.
- Do not dismantle, repair or alter this product on your own. Contact Bemis for assistance. Risk of fire, electric shock, and/or other accident that may lead to injury.
- For cleaning or maintenance of plastic parts, do not use any harsh cleaning agents. (These include, but are not limited to products such as; concentrated sulfuric acid, carbon tetrachloride, chloroform, acetone, butanone, benzene, methylbenzene, phenol, methylphenol, dimethylformamide, methyl ether, soybean oil, acetate, 40% nitric acid, thick salt acid, 95% alcohol, gasoline, kerosene or brake oil, etc). Risk of damaging parts that can lead to accidents and injuries.
- Do not add water or detergent into the unit or on to the wireless remote. Do not soak the product with water or cleaner. Risk of fire and/or electric shock.
- Do not install the product in a humid environment or a soak room. Do not spray or soak this product with any form of liquid to prevent any damage to the product. Risk of fire and/or electric shock.
- Do not install product in a humid environment or a soak room. Do not spray or soak this product with any form of liquid to prevent any damage to the product. Risk of fire and/or electric shock.
- Do not use polluted water or water meant for industrial. Risk of urocystitis or dermatitis. Unrelated water may also cause electrical shock or a fire.
- Do not apply any force to the unit's seat and lid. Do not stand on the lid or open or close the lid and the seat forcefully. This may result in product damage and/or user injury.
- Do not place your hand or any other object into the dryer trap, and do not cover the dryer and dryer trap during product use. Risk of fire, electric shock, and/or other accident that may lead to user injury.
- Do not spray urine at the dryer trap. Risk of electric shock.

WARNINGS & SAFETY (cont.)

READ THE FOLLOWING FOR PROPER BATTERY USAGE.

1. Properly install the battery according to its correct polarity.
 2. Remove the battery during long periods without use.
 3. Replace the battery before it reaches the end of its usage. Failure to do so may result in interrupted control signals.
 4. Cover the battery with tape before disposal. This will prevent battery fluid leaks that may cause fire and/or other damages.
- Place the battery out of reach of children and infant reach. If battery is swallowed, contact a doctor immediately.
 - If battery fluid leaks onto user, quickly rinse off area using water.
 - If battery fluid gets into eyes, do not rub your eyes. Quickly rinse it with water and consult a doctor immediately. May result in vision impairment or blindness.

WHEN THE BATTERY IS IN USE, DO NOT DO THE FOLLOWING:

- Do not hold or store with metal objects (such as necklace or watch).
- Do not mix new and old batteries.
- Do not pull battery apart or throw it into water and/or fire. Battery fluids may cause a fire.

ATTENTION

- Do not use the heated seat or warm dryer temperature for an extended amount of time. Extended use may result in burns.
- While using this product, make sure that the skin is in contact with the seat sensor area. Otherwise, product may not operate correctly. Children and smaller individuals may have trouble staying in contact with sensor area.
- Do not spray urine in the direction of the bidet nozzle. Doing so may result in blockage to the bidet nozzles and cleaning area.
- Do not use your old hose component. Use the one provided with your product. Anything else connected to the older hose may need to be replaced. Risk of water leakage and/or property loss/damage.
- In case of sudden power failure, remove the power plug and close the angle valve to prevent water leakage. Risk of water leakage and/or property loss/damage.
- Avoid direct sunlight or heat. Risk of product discoloration.
- Do not supply electricity with an external switch. ie: connecting the universal part to a timer switch. Run the risk of issues caused by improperly resetting the thermal breaker.
- When the filter is being replaced, be sure to close the water supply angle valve. When the filter is being installed, be sure to fasten it with force. Risk of water leak.
- Pull out the power plug when the product is in disuse for an extended amount of time. Make sure to shut off the water and remove the water inside the product. Risk of fire, leaks, and product damage.
- When storing or transporting in cold climate, make sure to remove all water from the unit. Product may crack and other damages may occur due to freezing water. Risk of fire, leaks, and product damage.

TROUBLESHOOTING

EXPERIENCING ISSUES?

If you experience any issues, please consult troubleshooting guide below.

If the problem persists, contact Bemis Customer Service.

Power/Stop

Issue	Diagnosis	Solutions
Product is not working.	Check if the power cord is loose.	Please check the circuit.
	Check if the product is powering on.	Press "Power/Stop" button.

Dryer

Issue	Diagnosis	Solutions
The dryer blows cold air.	Check the dryer settings.	Adjust the dryer settings.
	Check whether the heating element of dryer is damaged or not.	Contact Bemis Customer Service.

Heated Seat

Issue	Diagnosis	Solutions
The temperature of toilet seat is too low or is not heating.	Check the seat temperature settings.	Regulate the temperature of the toilet seat according to the instruction manual.

Wash Functions

Issue	Issue	Solutions
No water in the nozzle.	Check whether the water supply cuts off or not.	Restore the water supply.
	Check whether the angle valve switches off or not.	Open the angle valve.
	Check whether the inlet pipe is flexed or not.	The inlet pipe must be straight.
The water pressure is too low.	Check the water pressure settings.	Increase the water pressure settings.
Unusual water flow from the nozzle.	Abnormal operation.	Unplug the unit for the one minute before plugging it back in.
The water temperature is not warm enough.	Check the water temperature settings.	Increase the water temperature settings.
Water is leaking from the nozzle.	Solenoid valve no longer has any effect.	Contact Bemis Customer Service.
The cleaning function is not working normally.	Seat sensor malfunction.	Contact Bemis Customer Service.

Remote Control

Issue	Diagnosis	Solutions
The stop key is flashing.	Low Battery	Replace the battery.
Remote control is not working.	Check whether there is any water on the remote control.	Wipe off the remote.

TROUBLESHOOTING (cont.)

Toilet Unit

Issue	Diagnosis	Solutions
The product is not flushing clean when water pressure is low.	The filter is blocked.	Clean filter according to the instructions manual.
	The water pressure at home is too low.	Check whether the water amount is below 3L every 10 seconds or not. If it is, we suggest you buy a pressure increasing valve.
	The hose is bent.	Reconfigure the hose to a more smooth connection.
Flusher is not working.	Flush valve breakdown.	The inlet pipe must be straight.

Soft-Close Feature

Issue	Diagnosis	Solutions
The toilet seat/toilet cover opens or closes too fast.	Slow close damper is not functioning.	Contact Bemis Customer Service.
Kick Button is not functioning.	Slow close damper is not functioning.	Unplug the unit for one minute before plugging it back in.

SPECIFICATIONS



Rated voltage		120V
Frequency		60Hz
Rated power input		1050W (When inlet water temp in 59°F)
Seat and dryer temperature range		93.2°F~104°F
Water temperature range		39.4°F~ 95°F
Water supply hose type		DN15 (G1/2")
Water Inlet	Maximum Pressure	14.5 psi (Maximum flowing speed: 17L/min)
		108.78 psi (static state)
Toilet	Flush consumption	≤1.28 gal
	Flush type	Tornado flush
	Rough-in	Rough-in 12in
Nozzle	Heating Type	Instant Heating
	Rear wash water consumption	0.11-0.2 gal/min (3 Levels) when inlet water pressure is 29 psi
	Front wash water consumption	0.11-0.2 gal/min (3 Levels) when inlet water pressure is 29 psi
	Washing temp. range	OFF/86°F-104°F (4 Levels)
	Safety system	Butterfly thermostat, thermal fuse, flow sensor
Dryer	Dryer temp. range	OFF/95°F-131°F (4 Levels)
	Air speed	>4m/s
	Power input	350W
	Safety system	Thermal fuse, bi-metal
Heated seat	Heat temp. range	OFF/82.4°F-104°F (4 Levels)
	Power input	35W
	Safety system	Thermal fuse
Remote Control	Heat temp. range	7.48 in(L) 2.17in(W) 0.63 in(H)
	Power input	CR2030 Button Battery (2pcs)
Power cable length		Appx. 47.2 in
Product dimension		26.89 in (L) 15.75in (W) 16.30in (H)
Product weight		84.88 lb (Electric part 16.53 lb, Ceramic part 68.34 lb)

WARRANTY

Bemis warrants that this product will be free of defects in material, workmanship, and title for a period of two (2) years from the date of original purchase.

If you provide written notice of a defect to Bemis within the applicable warranty period and provide adequate documentation or evidence that establishes a Product defect to Bemis's satisfaction, your sole remedy is the repair, replacement, or refund of the Product's purchase price (less shipping, if applicable), at Bemis's option.

Bemis may, at its option, require the return of any Product for inspection and testing before honoring any defect claim. This Limited Warranty excludes component parts not specified by Bemis, and excludes costs related to shipping and labor, including removal, disposal, repair, or replacement of the defective Product and installation of replacement Product (if applicable). Products returned for a refund must be in original packaging and in saleable condition, and may be subject to a restocking fee. Discontinued colors or models, and custom or specially ordered Products cannot be returned for a refund.

This Limited Warranty is void if: (a) the Product has not been installed, used, or maintained according to any applicable written materials, including written instructions, specifications, packaging, and manuals; (b) the Product is not used for the intended application, or (c) the Product has been modified or repaired without Bemis's express written permission.

THIS LIMITED WARRANTY IS PROVIDED IN LIEU OF ALL OTHER WARRANTIES, EXPRESS OR IMPLIED, INCLUDING THE IMPLIED WARRANTIES OF MERCHANTABILITY AND FITNESS FOR A PARTICULAR PURPOSE. BEMIS EXPRESSLY DISCLAIMS LIABILITY FOR SPECIAL, PUNITIVE, EXEMPLARY, CONSEQUENTIAL OR INCIDENTAL DAMAGES ASSOCIATED WITH THE PRODUCT, INCLUDING LOST PROFITS OR BUSINESS INTERRUPTIONS. BEMIS'S LIABILITY UNDER THESE TERMS AND CONDITIONS SHALL NOT EXCEED THE PURCHASE PRICE OF THE PRODUCTS.

Please see [BemisMfg.com/terms-and-conditions](https://www.bemis.com/terms-and-conditions) for complete warranty terms.

Thank you
for your Bemis® bidet
toilet purchase!



Bemis Manufacturing Co.
Sheboygan Falls, Wisconsin U.S.A.

888.722.6488 | Corp@BemisMfg.com
ToiletSeats.com

071724